



BASIC ENGINEERING CIRCUIT ANALYSIS

ELEVENTH EDITION

J. DAVID IRWIN • R. MARK NELMS

WILEY

WileyPLUS

WileyPLUS is a research-based online environment for effective teaching and learning.

WileyPLUS builds students' confidence because it takes the guesswork out of studying by providing students with a clear roadmap:

- what to do
- how to do it
- if they did it right

It offers interactive resources along with a complete digital textbook that help students learn more. With *WileyPLUS*, students take more initiative so you'll have greater impact on their achievement in the classroom and beyond.



For more information, visit www.wileyplus.com

Now available for



Blackboard

WileyPLUS

ALL THE HELP, RESOURCES, AND PERSONAL SUPPORT YOU AND YOUR STUDENTS NEED!

www.wileyplus.com/resources

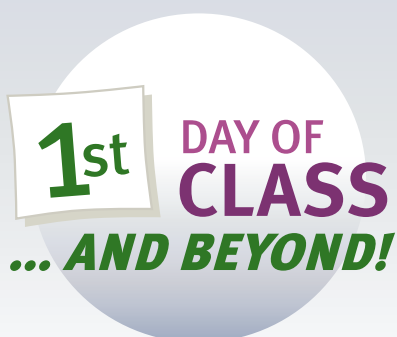

2-Minute Tutorials and all of the resources you and your students need to get started

WileyPLUS

Student
Partner
Program

Student support from an experienced student user

Wiley Faculty Network



Collaborate with your colleagues, find a mentor, attend virtual and live events, and view resources

www.WhereFacultyConnect.com

WileyPLUS

Quick
Start

Pre-loaded, ready-to-use assignments and presentations created by subject matter experts

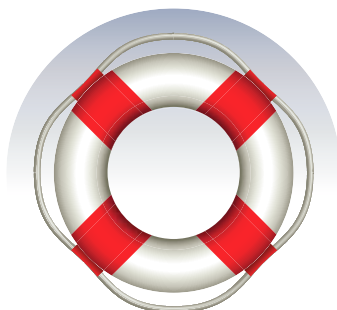

Technical Support 24/7
FAQs, online chat,
and phone support

www.wileyplus.com/support



© Courtney Keating/iStockphoto

Your *WileyPLUS* Account Manager, providing personal training and support

Basic Engineering Circuit Analysis

11e

J. David Irwin
Auburn University

R. Mark Nelms
Auburn University



VOLUME

WILEY

TREBLE

Vice President and Executive Publisher	Don Fowley
Executive Editor	Dan Sayre
Senior Content Manager	Karoline Luciano
Production Editor	James Metzger
Executive Marketing Manager	Christopher Ruel
Design Director	Harry Nolan
Senior Designer	Maureen Eide
Cover Designer	Tom Nery
Senior Photo Editor	Lisa Gee
Editorial Assistant	Francesca Baratta
Product Designer	Jennifer Welter
Associate Editor	Wendy Ashenberg
Cover Photo	© GrahamMoore999/iStockphoto
Chapter Opener Image	© liangpv/Digital Vision Vectors/Getty Images

This book was set in 10/12 Times LT Std by MPS Limited and printed and bound by Courier-Kendallville. The cover was printed by Courier-Kendallville.

Copyright © 2015, 2011, 2008, 2005

John Wiley & Sons, Inc. All rights reserved. No part of this publication may be reproduced, stored in a retrieval system or transmitted in any form or by any means, electronic, mechanical, photocopying, recording, scanning or otherwise, except as permitted under Sections 107 or 108 of the 1976 United States Copyright Act, without either the prior written permission of the Publisher, or authorization through payment of the appropriate per-copy fee to the Copyright Clearance Center, Inc. 222 Rosewood Drive, Danvers, MA 01923, website www.copyright.com. Requests to the Publisher for permission should be addressed to the Permissions Department, John Wiley & Sons, Inc., 111 River Street, Hoboken, NJ 07030-5774, (201)748-6011, fax (201)748-6008, website <http://www.wiley.com/go/permissions>.

Multisim is a trademark of National Instruments. Neither Wiley, nor any software programs or other goods or services offered by Wiley, are affiliated with, endorsed by, or sponsored by National Instruments.

PSpice is a registered trademark of Cadence Design Systems, Inc. in the United States and/or other jurisdictions.

MATLAB is a registered trademark of The MathWorks, Inc.

Founded in 1807, John Wiley & Sons, Inc. has been a valued source of knowledge and understanding for more than 200 years, helping people around the world meet their needs and fulfill their aspirations. Our company is built on a foundation of principles that include responsibility to the communities we serve and where we live and work. In 2008, we launched a Corporate Citizenship Initiative, a global effort to address the environmental, social, economic, and ethical challenges we face in our business. Among the issues we are addressing are carbon impact, paper specifications and procurement, ethical conduct within our business and among our vendors, and community and charitable support. For more information, please visit our website: www.wiley.com/go/citizenship.

Evaluation copies are provided to qualified academics and professionals for review purposes only, for use in their courses during the next academic year. These copies are licensed and may not be sold or transferred to a third party. Upon completion of the review period, please return the evaluation copy to Wiley. Return instructions and a free of charge return shipping label are available at www.wiley.com/go/returnlabel. Outside of the United States, please contact your local representative.

ISBN-13 978-1-118-53929-3
BRV ISBN-13: 978-1-118-99266-1

Library of Congress Cataloging-in-Publication Data

Irwin, J. David, 1939-

Basic engineering circuit analysis/J. David Irwin, R. Mark Nelms.—11th edition.

1 online resource.

Includes bibliographical references and index.

Description based on print version record and CIP data provided by publisher; resource not viewed.

ISBN 978-1-118-95598-7 (pdf)—ISBN 978-1-118-53929-3 (cloth : alk. paper) 1. Electric circuit analysis—Textbooks. 2. Electronics—Textbooks. I. Nelms, R. M. II. Title.

TK454

621.3815—dc23

2014046173

Printed in the United States of America

10 9 8 7 6 5 4 3 2 1

To my loving family:

Edie
Geri, Bruno, Andrew, and Ryan
John, Julie, John David, and Abi
Laura

To my parents:

Robert and Elizabeth Nelms



BRIEF CONTENTS

- Chapter 1** Basic Concepts 1
- Chapter 2** Resistive Circuits 24
- Chapter 3** Nodal and Loop Analysis Techniques 89
- Chapter 4** Operational Amplifiers 147
- Chapter 5** Additional Analysis Techniques 171
- Chapter 6** Capacitance and Inductance 219
- Chapter 7** First- and Second-Order Transient Circuits 252
- Chapter 8** AC Steady-State Analysis 305
- Chapter 9** Steady-State Power Analysis 362
- Chapter 10** Magnetically Coupled Networks 411
- Chapter 11** Polyphase Circuits 450
- Chapter 12** Variable-Frequency Network Performance 482
- Chapter 13** The Laplace Transform 543
- Chapter 14** Application of the Laplace Transform to
Circuit Analysis 569
- Chapter 15** Fourier Analysis Techniques 617
- Appendix** Complex Numbers 659

CONTENTS

Preface ix

Chapter one

Basic Concepts 1

- 1.1 System of Units 2
- 1.2 Basic Quantities 2
- 1.3 Circuit Elements 8
 - Summary 17
 - Problems 18

Chapter two

Resistive Circuits 24

- 2.1 Ohm's Law 25
- 2.2 Kirchhoff's Laws 30
- 2.3 Single-Loop Circuits 38
- 2.4 Single-Node-Pair Circuits 45
- 2.5 Series and Parallel Resistor Combinations 50
- 2.6 Wye \iff Delta Transformations 59
- 2.7 Circuits with Dependent Sources 63
 - Summary 68
 - Problems 69

Chapter three

Nodal and Loop Analysis Techniques 89

- 3.1 Nodal Analysis 90
- 3.2 Loop Analysis 111
 - Summary 128
 - Problems 129

Chapter four

Operational Amplifiers 147

- 4.1 Introduction 148
- 4.2 Op-Amp Models 148
- 4.3 Fundamental Op-Amp Circuits 154
 - Summary 163
 - Problems 163

Chapter five

Additional Analysis Techniques 171

- 5.1 Introduction 172
- 5.2 Superposition 174

- 5.3 Thévenin's and Norton's Theorems 179

- 5.4 Maximum Power Transfer 197

- Summary 202

- Problems 202

Chapter six

Capacitance and Inductance 219

- 6.1 Capacitors 220
- 6.2 Inductors 227
- 6.3 Capacitor and Inductor Combinations 236
 - Summary 241
 - Problems 241

Chapter seven

First- and Second-Order Transient Circuits 252

- 7.1 Introduction 253
- 7.2 First-Order Circuits 254
- 7.3 Second-Order Circuits 275
 - Summary 289
 - Problems 289

Chapter eight

AC Steady-State Analysis 305

- 8.1 Sinusoids 306
- 8.2 Sinusoidal and Complex Forcing Functions 309
- 8.3 Phasors 312
- 8.4 Phasor Relationships for Circuit Elements 314
- 8.5 Impedance and Admittance 318
- 8.6 Phasor Diagrams 325
- 8.7 Basic Analysis Using Kirchhoff's Laws 328
- 8.8 Analysis Techniques 331
 - Summary 344
 - Problems 344

Chapter nine

Steady-State Power Analysis 362

- 9.1 Instantaneous Power 363
- 9.2 Average Power 364
- 9.3 Maximum Average Power Transfer 369
- 9.4 Effective or rms Values 374
- 9.5 The Power Factor 377
- 9.6 Complex Power 379

- 9.7 Power Factor Correction 384
- 9.8 Single-Phase Three-Wire Circuits 388
- 9.9 Safety Considerations 391
 - Summary 399
 - Problems 399

Chapter ten

Magnetically Coupled Networks 411

- 10.1 Mutual Inductance 412
- 10.2 Energy Analysis 423
- 10.3 The Ideal Transformer 426
- 10.4 Safety Considerations 436
 - Summary 437
 - Problems 438

Chapter eleven

Polyphase Circuits 450

- 11.1 Three-Phase Circuits 451
- 11.2 Three-Phase Connections 456
- 11.3 Source/Load Connections 457
- 11.4 Power Relationships 466
- 11.5 Power Factor Correction 471
 - Summary 475
 - Problems 475

Chapter twelve

Variable-Frequency Network Performance 482

- 12.1 Variable Frequency-Response Analysis 483
- 12.2 Sinusoidal Frequency Analysis 491
- 12.3 Resonant Circuits 500
- 12.4 Scaling 521
- 12.5 Filter Networks 523
 - Summary 534
 - Problems 535

Chapter thirteen

The Laplace Transform 543

- 13.1 Definition 544
- 13.2 Two Important Singularity Functions 544

- 13.3 Transform Pairs 547
- 13.4 Properties of the Transform 549
- 13.5 Performing the Inverse Transform 551
- 13.6 Convolution Integral 557
- 13.7 Initial-Value and Final-Value Theorems 560
- 13.8 Solving Differential Equations with Laplace Transforms 562
 - Summary 564
 - Problems 564

Chapter fourteen

Application of the Laplace Transform to Circuit Analysis 569

- 14.1 Laplace Circuit Solutions 570
- 14.2 Circuit Element Models 571
- 14.3 Analysis Techniques 573
- 14.4 Transfer Function 586
- 14.5 Steady-State Response 603
 - Summary 606
 - Problems 606

Chapter fifteen

Fourier Analysis Techniques 617

- 15.1 Fourier Series 618
- 15.2 Fourier Transform 641
 - Summary 651
 - Problems 651

Appendix

Complex Numbers 659

Index 666

PREFACE

Circuit analysis is not only fundamental to the entire breadth of electrical and computer engineering—the concepts studied here extend far beyond those boundaries. For this reason, it remains the starting point for many future engineers who wish to work in this field. The text and all the supplementary materials associated with it will aid you in reaching this goal. We strongly recommend while you are here to read the Preface closely and view all the resources available to you as a learner. One last piece of advice: Learning to analyze electric circuits is like learning to play a musical instrument. Most people take music lessons as a starting point. Then, they become proficient through practice, practice, and more practice. Lessons on circuit analysis are provided by your instructor and this textbook. Proficiency in circuit analysis can only be obtained through practice. Take advantage of the many opportunities throughout this textbook to practice, practice, and practice. In the end, you'll be thankful you did.

To the Student

The Eleventh Edition has been prepared based on a careful examination of feedback received from instructors and students. The revisions and changes made should appeal to a wide variety of instructors. We are aware of significant changes taking place in the way this material is being taught and learned. Consequently, the authors and the publisher have created a formidable array of traditional and nontraditional learning resources to meet the needs of students and teachers of modern circuit analysis.

To the Instructor

By design, the book contains an enormous number of end-of-chapter problems that provide significant advantages for the instructor. As a time-saving measure, the instructor can use this bank of problems to select both homework problems and exam questions, term after term, without repetition. Dedicated students will find this problem set, typically graduated in difficulty, an excellent resource for testing their understanding on a range of problems.

Flipping the classroom has risen recently as an alternative mode of instruction, which attempts to help the student grasp the material quicker. Studies to date have shown that this mode also tends to minimize instructor office time. This book, with its combination of Learning Assessments, problem-solving videos, and WileyPLUS software, is an ideal vehicle for teaching in this format. These resources provide the instructor with the tools necessary to modify the format of the presentation in the hope of enhancing the student's rapid understanding of the material.

Engineering educators have long recognized that coupling traditional lecture courses with laboratory experiences enhances student interest and learning. The trend in hands-on learning has been spurred by the development of inexpensive USB-powered instruments and inexpensive portable laboratory kits that allow the student to explore electrical theory in environments that vary from a traditional laboratory classroom to an environment where the experiments can be performed anywhere at any time. Research has shown that students gain a deeper understanding of abstract theoretical concepts when the concepts are applied in practical circuits. The response of students, both male and female, to hands-on learning with such kits has been overwhelmingly positive. New to this edition, a list of such experiments is provided at the beginning of each chapter. The experiments, which demonstrate some of the concepts introduced in the chapters, can be conducted under the guidance of an instructor or independently.

In accordance with the earlier editions, the book contains a plethora of examples that are designed to help the student grasp the salient features of the material quickly. A number of new examples have been introduced, and MATLAB[®] has been employed, where appropriate, to provide a quick and easy software solution as a means of comparison, as well as to check on other solution techniques.

Highlights of the Eleventh Edition

- A four-color design is employed to enhance and clarify both text and illustrations. This sharply improves the pedagogical presentation, particularly with complex illustrations. For example, see Figure 2.5 on page 30.
- End-of-chapter homework problems have been substantially revised and augmented. There are now approximately 1,400 problems in the Eleventh Edition, of which over 400 are new! Multiple-choice Fundamentals of Engineering (FE) Exam problems also appear at the end of each chapter.
- Problem-solving videos (PSVs) have been created, showing students step by step how to solve all Learning Assessment problems within each chapter. This is a special feature that should significantly enhance the learning experience for each subsection in a chapter.
- In order to provide maximum flexibility, online supplements contain solutions to examples in the book using MATLAB, PSpice®, or MultiSim®. The worked examples can be supplied to students as digital files, or one or more of them can be incorporated into custom print editions of the text, depending on the instructor's preference.
- Problem-Solving Strategies have been retained in the Eleventh Edition. They are utilized as a guide for the solutions contained in the PSVs.
- The WileyPLUS resources have been greatly updated and expanded, with additional algorithmic problems, PSVs, and much more. Reading Quiz questions give instructors the opportunity to track student reading and measure their comprehension. Math Skills Assessments provide faculty with tools to assess students' mastery of essential mathematical concepts. Not only can faculty measure their students' math comprehension at the beginning of the term, they also now have resources to which they can direct students to reinforce areas where they need to upgrade their skills.
- Experiments are paired with each chapter so that students can see in action the concepts discussed in the chapter through the use of both predefined physical circuits and independent design projects.

Organization

This text is suitable for a one-semester, a two-semester, or a three-quarter course sequence. The first seven chapters are concerned with the analysis of dc circuits. An introduction to operational amplifiers is presented in Chapter 4. This chapter may be omitted without any loss of continuity. Chapters 8 to 12 are focused on the analysis of ac circuits, beginning with the analysis of single-frequency circuits (single-phase and three-phase) and ending with variable-frequency circuit operation. Calculation of power in single-phase and three-phase ac circuits is also presented. The important topics of the Laplace transform and Fourier transform are covered in Chapters 13 to 15.

The organization of the text provides instructors maximum flexibility in designing their courses. One instructor may choose to cover the first seven chapters in a single semester, while another may omit Chapter 4 and cover Chapters 1 to 3 and 5 to 8. Other instructors have chosen to cover Chapters 1 to 3, 5 to 6, and section 7.1, and then cover Chapters 8 and 9. The remaining chapters can be covered in a second semester course.

Text Pedagogy

The pedagogy of this text is rich and varied. It includes print and media, and much thought has been put into integrating its use. To gain the most from this pedagogy, please review the following elements commonly available in most chapters of this book.

Learning Objectives are provided at the outset of each chapter. This tabular list tells the reader what is important and what will be gained from studying the material in the chapter.

Experiments that reinforce the learning objectives are listed with brief descriptions of what the student will gain by performing each experiment. Most experiments also involve simulating the circuit with computer software to verify/predict correct operation.

Examples are the mainstay of any circuit analysis text, and numerous examples have always been a trademark of this textbook. These examples provide a more graduated level of presentation with simple, medium, and challenging examples.

Hints can often be found in the page margins. They facilitate understanding and serve as reminders of key issues. See, for example, page 9.

Learning Assessments are a critical learning tool in this text. These exercises test the cumulative concepts to that point in a given section or sections. Not only is the answer provided, but a problem-solving video accompanies each of these exercises, demonstrating the solution in step-by-step detail. The student who masters these is ready to move forward. See, for example, page 11.

Problem-Solving Strategies are step-by-step problem-solving techniques that many students find particularly useful. They answer the frequently asked question, “Where do I begin?” Nearly every chapter has one or more of these strategies, which are a kind of summation on problem solving for concepts presented. See, for example, page 44.

Problems have been greatly revised for the Eleventh Edition. This edition has over 400 new problems of varying depth and level. Any instructor will find numerous problems appropriate for any level class. There are approximately 1,400 problems in the Eleventh Edition! Included with the problems are **FE Exam Problems** for each chapter. If you plan on taking the FE Exam, these problems closely match problems you will typically find on the FE Exam.

Circuit Simulation and Analysis Software represents a fundamental part of engineering circuit design today. Software such as **PSpice**, **MultiSim**, and **MATLAB** allow engineers to design and simulate circuits quickly and efficiently. As an enhancement with enormous flexibility, all three of these software packages can be employed in the Eleventh Edition. In each case, online supplements are available that contain the solutions to numerous examples in each of these software programs. Instructors can opt to make this material available online or as part of a customized print edition, making this software an integral and effective part of the presentation of course material.

The rich collection of material that is provided for this edition offers a distinctive and helpful way for exploring the book’s examples and exercises from a variety of simulation techniques.

WileyPLUS is an innovative, research-based, online environment for effective teaching and learning.



WHAT DO STUDENTS RECEIVE WITH WILEYPLUS? *A Research-Based Design:* WileyPLUS provides an online environment that integrates relevant resources, including the entire digital textbook, in an easy-to-navigate framework that helps students study more effectively.

- WileyPLUS adds structure by organizing textbook content into smaller, more manageable “chunks.”
- Related media, examples, and sample practice items reinforce the learning objectives.
- Innovative features such as calendars, visual progress tracking, and self-evaluation tools improve time management and strengthen areas of weakness.

One-on-One Engagement: With WileyPLUS, students receive 24/7 access to resources that promote positive learning outcomes. Students engage with related examples (in various media) and sample practice items, including:

- FE Exam Questions
- Reading Quiz Questions

- Circuit Solutions
- Learning Assessments
- Math Skills Assessments

Measurable Outcomes: Throughout each study session, students can assess their progress and gain immediate feedback. WileyPLUS provides precise reporting of strengths and weaknesses, as well as individualized quizzes, so that students are confident that they are spending their time on the right things. With WileyPLUS, students always know the exact outcome of their efforts.

WHAT DO INSTRUCTORS RECEIVE WITH WILEYPLUS? WileyPLUS provides reliable, customizable resources that reinforce course goals inside and outside of the classroom, as well as visibility into individual student progress. Precreated materials and activities help instructors optimize their time.

Customizable Course Plan: WileyPLUS comes with a precreated course plan designed by a subject matter expert uniquely for this course. Simple drag-and-drop tools make it easy to assign the course plan as-is or modify it to reflect your course syllabus.

Precreated Activity Types include:

- Questions
- Readings and Resources
- Presentation
- Print Tests
- Concept Mastery

Course Materials and Assessment Content:

- Lecture Notes
- PowerPoint Slides
- Image Gallery
- Instructor's Manual
- Gradable Reading Assignment Questions (embedded with online text)
- Question Assignments: All end-of-chapter problems are coded algorithmically with hints, links to text, whiteboard/show work feature, and instructor-controlled problem-solving help.

Gradebook: WileyPLUS provides instant access to reports on trends in class performance, student use of course materials, and progress toward learning objectives, helping inform decisions and drive classroom discussions.

Learn more about WileyPLUS at www.wileyplus.com.

Powered by proven technology and built on a foundation of cognitive research, WileyPLUS has enriched the education of millions of students in more than 20 countries.

Supplements

The supplements list is extensive and provides instructors and students with a wealth of traditional and modern resources to match different learning needs.

Problem-Solving Videos are offered again in the Eleventh Edition in an iPod-compatible format. The videos provide step-by-step solutions to Learning Assessments. Videos for Learning Assessments will follow directly after a chapter feature called *Problem-Solving Strategy*. Students who have used these videos with past editions have found them to be very helpful.

The **Solutions Manual** for the Eleventh Edition has been completely redone, checked, and double-checked for accuracy. Although it is hand-written to avoid typesetting errors, it is the most

accurate solutions manual ever created for this textbook. Qualified instructors who adopt the text for classroom use can download it off Wiley's Instructor Companion Site.

PowerPoint Lecture Slides are an especially valuable supplementary aid for some instructors. While most publishers make only figures available, these slides are true lecture tools that summarize the key learning points for each chapter and are easily editable in PowerPoint. The slides are available for download from Wiley's Instructor Companion Site for qualified adopters.

Lab-in-a-Box: Introductory Experiments in Electric Circuits is a collection of laboratory experiments made available within WileyPLUS or as a companion publication. The experiments have been designed for a range of instructional settings, from traditional laboratory classes through at-home experimentation. This allows the instructor to choose the instructional environment for the experiments. Videos to support students as they perform the experiments are also available in WileyPLUS.

Over the more than three decades that this text has been in existence, we estimate that more than one thousand instructors have used our book in teaching circuit analysis to hundreds of thousands of students. As authors, there is no greater reward than having your work used by so many. We are grateful for the confidence shown in our text and for the numerous evaluations and suggestions from professors and their students over the years. This feedback has helped us continuously improve the presentation. For this Eleventh Edition, we especially thank Brandon Eidson and Elizabeth Devore with Auburn University for their assistance with the solutions manual.

We were fortunate to have an outstanding group of faculty who has participated in reviews, surveys, and focus groups for this edition:

Jorge Aravena, Louisiana State University
 Cindy Barnicki, Milwaukee School of Engineering
 Kurt Becker, Utah State University
 Yugal Behl, CNM Community College
 Christopher Bise, West Virginia University
 April Bryan, Rose-Hulman
 James Conrad, University of North Carolina–Charlotte
 Roy Craig, University of Texas–Austin
 Janak Dave, University of Cincinnati
 Richard DuBroff, Missouri University of Science & Technology
 Kim Fitzgerald, University of Illinois–Chicago
 Manfred Hampe, TU Darmstadt
 Melinda Holtzman, Portland State University
 Bill Hornfeck, Lafayette College
 Paul King, Vanderbilt University
 Steve Krause, Arizona State University
 Gordon Lee, San Diego State University
 Janice Margle, Penn State University–Abington
 Maditumi Mitra, University of Maryland
 Abhijit Nagchaudhuri, University of Maryland–Eastern Shore
 Bahram Nassersharif, University of Rhode Island
 Tokunbo Ogunfunmi, Santa Clara University
 Michael Polis, Oakland University
 Kanti Prasad, University of Massachusetts–Lowell
 Robert Steker, WCTC
 Yu Sun, University of Toronto
 Nina Telang, University of Texas–Austin
 Natalie VanTyne, Colorado School of Mines
 Lale Yurttas, Texas A&M University
 Tim Zeigler, Southern Polytechnic State University

Acknowledgments

The preparation of this book and the materials that support it have been handled with both enthusiasm and great care. The combined wisdom and leadership of our colleagues at Wiley has resulted in a tremendous team effort that has addressed every aspect of the presentation. This team included the following individuals:

VP and Executive Publisher, Don Fowley
 Executive Editor, Dan Sayre
 Product Designer, Jennifer Welter
 Executive Marketing Manager, Christopher Ruel
 Production Editor, James Metzger
 Senior Designer, Maureen Eide
 Senior Content Manager, Karoline Luciano
 Senior Photo Editor, Lisa Gee
 Associate Editor, Wendy Ashenberg
 Editorial Assistant, Francesca Baratta

Each member of this team played a vital role in preparing the package that is the Eleventh Edition of *Basic Engineering Circuit Analysis*. We are most appreciative of their many contributions.

As in the past, we are most pleased to acknowledge the support that has been provided by numerous individuals to earlier editions of this book. Our Auburn colleagues who have helped are:

Thomas A. Baginski	Matthew Langford
Travis Blalock	Aleck Leedy
Henry Cobb	George Lindsey
Elizabeth Devore	Jo Ann Loden
Bill Dillard	James L. Lowry
Zhi Ding	David Mack
Kevin Driscoll	Paulo R. Marino
Brandon Eidson	M. S. Morse
E. R. Graf	Sung-Won Park
L. L. Grigsby	John Parr
Charles A. Gross	Monty Rickles
Stephen Haddock	C. L. Rogers
David C. Hill	Tom Shumpert
M. A. Honnell	Les Simonton
R. C. Jaeger	James Trivltayakhum
Keith Jones	Susan Williamson
Betty Kelley	Jacinda Woodward
Ray Kirby	

Many of our friends throughout the United States, some of whom are now retired, have also made numerous suggestions for improving the book:

David Anderson, University of Iowa
 Jorge Aravena, Louisiana State University
 Les Axelrod, Illinois Institute of Technology
 Richard Baker, UCLA
 Charles F. Bunting, Oklahoma State University
 John Choma, University of Southern California
 David Conner, University of Alabama at Birmingham
 James L. Dodd, Mississippi State University
 Kevin Donahue, University of Kentucky
 John Durkin, University of Akron
 Prasad Enjeti, Texas A&M University
 Earl D. Eyman, University of Iowa
 Arvin Gabel, Northeastern University
 Paul Gray, University of Wisconsin–Platteville
 Ashok Goel, Michigan Technological University

Walter Green, University of Tennessee
 Paul Greiling, UCLA
 Mohammad Habli, University of New Orleans
 John Hadjiligiou, Florida Institute of Technology
 Yasser Hegazy, University of Waterloo
 Keith Holbert, Arizona State University
 Aileen Honka, The MOSIS Service–USC Information Sciences Institute
 Marty Kaliski, Cal Poly, San Luis Obispo
 Ralph Kinney, Louisiana State University
 Muhammad A. Khaliq, Minnesota State University
 Robert Krueger, University of Wisconsin
 K. S. P. Kumar, University of Minnesota
 Jung Young Lee, UC Berkeley (student)
 Aleck Leedy, Murray State University
 Hongbin Li, Stevens Institute of Technology
 James Luster, Snow College
 Erik Luther, National Instruments
 Ian McCausland, University of Toronto
 Arthur C. Moeller, Marquette University
 Darryl Morrell, Arizona State University
 M. Paul Murray, Mississippi State University
 Burks Oakley II, University of Illinois at Champaign–Urbana
 John O’Malley, University of Florida
 Arnost Neugroschel, University of Florida
 William R. Parkhurst, Wichita State University
 Peyton Peebles, University of Florida
 Jian Peng, Southeast Missouri State University
 Clifford Pollock, Cornell University
 George Prans, Manhattan College
 Mark Rabalais, Louisiana State University
 Tom Robbins, National Instruments
 Armando Rodriguez, Arizona State University
 James Rowland, University of Kansas
 Robert N. Sackett, Normandale Community College
 Richard Sanford, Clarkson University
 Peddapullaiah Sannuti, Rutgers University
 Ronald Schulz, Cleveland State University
 M. E. Shafeei, Penn State University at Harrisburg
 Martha Sloan, Michigan Technological University
 Scott F. Smith, Boise State University
 Karen M. St. Germaine, University of Nebraska
 Janusz Strazyk, Ohio University
 Gene Stuffle, Idaho State University
 Thomas M. Sullivan, Carnegie Mellon University
 Saad Tabet, Florida State University
 Val Tareski, North Dakota State University
 Thomas Thomas, University of South Alabama
 Leonard J. Tung, Florida A&M University/Florida State University
 Marian Tzolov, Lock Haven University
 Darrell Vines, Texas Tech University
 Carl Wells, Washington State University
 Seth Wolpert, University of Maine

Finally, Dave Irwin wishes to express his deep appreciation to his wife, Edie, who has been most supportive of our efforts in this book. Mark Nelms would like to thank his parents, Robert and Elizabeth, for their support and encouragement.

J. David Irwin and R. Mark Nelms

Chapter One

THE LEARNING GOALS FOR THIS CHAPTER ARE THAT STUDENTS SHOULD BE ABLE TO:

- Use appropriate SI units and standard prefixes when calculating voltages, currents, resistances, and powers.
- Explain the relationships between basic electrical quantities: voltage, current, and power.
- Use the appropriate symbols for independent and dependent voltage and current sources.
- Calculate the value of the dependent sources when analyzing a circuit that contain independent and dependent sources.
- Calculate the power absorbed by a circuit element using the passive sign convention.

BASIC CONCEPTS

EXPERIMENTS THAT HELP STUDENTS DEVELOP AN UNDERSTANDING OF BASIC ELECTRIC CIRCUIT CONCEPTS ARE:

- Breadboard Basics: Learn the operation of a digital multimeter while mapping the connections on a breadboard via resistance measurements.
- Resistance Tolerances: Measure the resistance of real resistors and apply statistical analysis to the experimental values to explain nominal resistance and tolerance.
- Voltage Polarity and Direction of Current: Discover how dc currents and voltages are measured using a digital multimeter so that the resulting power calculated follows the passive sign convention.



1.1 System of Units

The system of units we employ is the international system of units, the *Système International des Unités*, which is normally referred to as the SI standard system. This system, which is composed of the basic units meter (m), kilogram (kg), second (s), ampere (A), kelvin (K), and candela (cd), is defined in all modern physics texts and therefore will not be defined here. However, we will discuss the units in some detail as we encounter them in our subsequent analyses.

The standard prefixes that are employed in SI are shown in **Fig. 1.1**. Note the decimal relationship between these prefixes. These standard prefixes are employed throughout our study of electric circuits.

Circuit technology has changed drastically over the years. For example, in the early 1960s the space on a circuit board occupied by the base of a single vacuum tube was about the size of a quarter (25-cent coin). Today that same space could be occupied by an Intel Pentium integrated circuit chip containing 50 million transistors. These chips are the engine for a host of electronic equipment.

Figure 1.1

Standard SI prefixes.

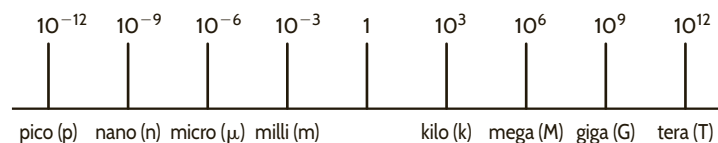

1.2 Basic Quantities

Before we begin our analysis of electric circuits, we must define terms that we will employ. However, in this chapter and throughout the book, our definitions and explanations will be as simple as possible to foster an understanding of the use of the material. No attempt will be made to give complete definitions of many of the quantities because such definitions are not only unnecessary at this level but are often confusing. Although most of us have an intuitive concept of what is meant by a circuit, we will simply refer to an *electric circuit* as an interconnection of electrical components, each of which we will describe with a mathematical model.

The most elementary quantity in an analysis of electric circuits is the electric *charge*. Our interest in electric charge is centered around its motion, since charge in motion results in an energy transfer. Of particular interest to us are those situations in which the motion is confined to a definite closed path.

An electric circuit is essentially a pipeline that facilitates the transfer of charge from one point to another. The time rate of change of charge constitutes an electric *current*. Mathematically, the relationship is expressed as

$$i(t) = \frac{dq(t)}{dt} \quad \text{or} \quad q(t) = \int_{-\infty}^t i(x) dx \quad 1.1$$

where i and q represent current and charge, respectively (lowercase letters represent time dependency, and capital letters are reserved for constant quantities). The basic unit of current is the ampere (A), and 1 ampere is 1 coulomb per second.

Although we know that current flow in metallic conductors results from electron motion, the conventional current flow, which is universally adopted, represents the movement of positive charges. It is important that the reader think of current flow as the movement of positive charge regardless of the physical phenomena that take place. The symbolism that will be used to represent current flow is shown in **Fig. 1.2**. $I_1 = 2 \text{ A}$ in **Fig. 1.2a** indicates that at any point in the wire shown, 2 C of charge pass from left to right each second. $I_2 = -3 \text{ A}$ in **Fig. 1.2b** indicates that at any point in the wire shown, 3 C of charge pass from right to left each second. Therefore, it is important to specify not only the magnitude of the variable representing the current but also its direction.

The two types of current that we encounter often in our daily lives, alternating current (ac) and direct current (dc), are shown as a function of time in **Fig. 1.3**. *Alternating current* is the common current found in every household and is used to run the refrigerator, stove, washing

Figure 1.2

Conventional current flow:
 (a) positive current flow;
 (b) negative current flow.

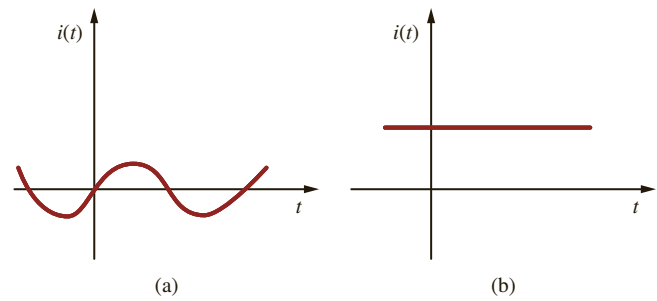
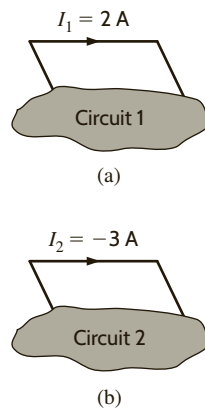
**Figure 1.3**

Two common types of current: (a) alternating current (ac);
 (b) direct current (dc).

machine, and so on. Batteries, which are used in automobiles and flashlights, are one source of *direct current*. In addition to these two types of currents, which have a wide variety of uses, we can generate many other types of currents. We will examine some of these other types later in the book. In the meantime, it is interesting to note that the magnitude of currents in elements familiar to us ranges from soup to nuts, as shown in **Fig. 1.4**.

We have indicated that charges in motion yield an energy transfer. Now we define the *voltage* (also called the *electromotive force*, or *potential*) between two points in a circuit as the difference in energy level of a unit charge located at each of the two points. Voltage is very similar to a gravitational force. Think about a bowling ball being dropped from a ladder into a tank of water. As soon as the ball is released, the force of gravity pulls it toward the bottom of the tank. The potential energy of the bowling ball decreases as it approaches the bottom. The gravitational force is pushing the bowling ball through the water. Think of the bowling ball as a charge and the voltage as the force pushing the charge through a circuit. Charges in motion represent a current, so the motion of the bowling ball could be thought of as a current. The water in the tank will resist the motion of the bowling ball. The motion of charges in an electric circuit will be impeded or resisted as well. We will introduce the concept of resistance in Chapter 2 to describe this effect.

Work or energy, $w(t)$ or W , is measured in joules (J); 1 joule is 1 newton meter ($\text{N}\cdot\text{m}$). Hence, voltage [$v(t)$ or V] is measured in volts (V) and 1 volt is 1 joule per coulomb; that is, 1 volt = 1 joule per coulomb = 1 newton meter per coulomb. If a unit positive charge is moved between two points, the energy required to move it is the difference in energy level between the two points and is the defined voltage. It is extremely important that the variables

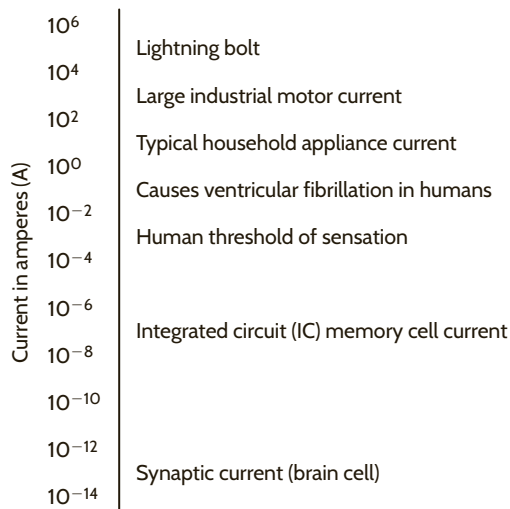
**Figure 1.4**

Typical current magnitudes.

Figure 1.5

Voltage representations.

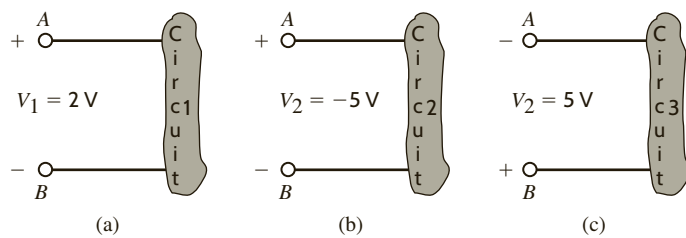

used to represent voltage between two points be defined in such a way that the solution will let us interpret which point is at the higher potential with respect to the other.

In **Fig. 1.5a** the variable that represents the voltage between points A and B has been defined as V_1 , and it is assumed that point A is at a higher potential than point B , as indicated by the $+$ and $-$ signs associated with the variable and defined in the figure. The $+$ and $-$ signs define a reference direction for V_1 . If $V_1 = 2\text{ V}$, then the difference in potential of points A and B is 2 V and point A is at the higher potential. If a unit positive charge is moved from point A through the circuit to point B , it will give up energy to the circuit and have 2 J less energy when it reaches point B . If a unit positive charge is moved from point B to point A , extra energy must be added to the charge by the circuit, and hence the charge will end up with 2 J more energy at point A than it started with at point B .

For the circuit in **Fig. 1.5b**, $V_2 = -5\text{ V}$ means that the potential between points A and B is 5 V and point B is at the higher potential. The voltage in **Fig. 1.5b** can be expressed as shown in **Fig. 1.5c**. In this equivalent case, the difference in potential between points A and B is $V_2 = 5\text{ V}$, and point B is at the higher potential.

Note that it is important to define a variable with a reference direction so that the answer can be interpreted to give the physical condition in the circuit. We will find that it is not possible in many cases to define the variable so that the answer is positive, and we will also find that it is not necessary to do so.

As demonstrated in **Figs. 1.5b** and **c**, a negative number for a given variable, for example, V_2 in **Fig. 1.5b**, gives exactly the same information as a positive number; that is, V_2 in **Fig. 1.5c**, except that it has an opposite reference direction. Hence, when we define either current or voltage, it is absolutely necessary that we specify both magnitude and direction. Therefore, it is incomplete to say that the voltage between two points is 10 V or the current in a line is 2 A , since only the magnitude and not the direction for the variables has been defined.

The range of magnitudes for voltage, equivalent to that for currents in **Fig. 1.4**, is shown in **Fig. 1.6**. Once again, note that this range spans many orders of magnitude.

At this point we have presented the conventions that we employ in our discussions of current and voltage. *Energy* is yet another important term of basic significance. Let's investigate the voltage–current relationships for energy transfer using the flashlight shown in **Fig. 1.7**. The basic elements of a flashlight are a battery, a switch, a light bulb, and connecting wires. Assuming a good battery, we all know that the light bulb will glow when the switch is closed. A current now flows in this closed circuit as charges flow out of the positive terminal of the battery through the switch and light bulb and back into the negative terminal of the battery. The current heats up the filament in the bulb, causing it to glow and emit light. The light bulb converts electrical energy to thermal energy; as a result, charges passing through the bulb lose energy. These charges acquire energy as they pass through the battery as chemical energy is converted to electrical energy. An energy conversion process is occurring in the flashlight as the chemical energy in the battery is converted to electrical energy, which is then converted to thermal energy in the light bulb.

Let's redraw the flashlight as shown in **Fig. 1.8**. There is a current I flowing in this diagram. Since we know that the light bulb uses energy, the charges coming out of the bulb have less energy than those entering the light bulb. In other words, the charges expend energy as they move through the bulb. This is indicated by the voltage shown across the bulb. The charges gain energy as they pass through the battery, which is indicated by the voltage across the battery. Note the voltage–current relationships for the battery and bulb. We know that the bulb is absorbing energy; the current is entering the positive terminal of the voltage. For

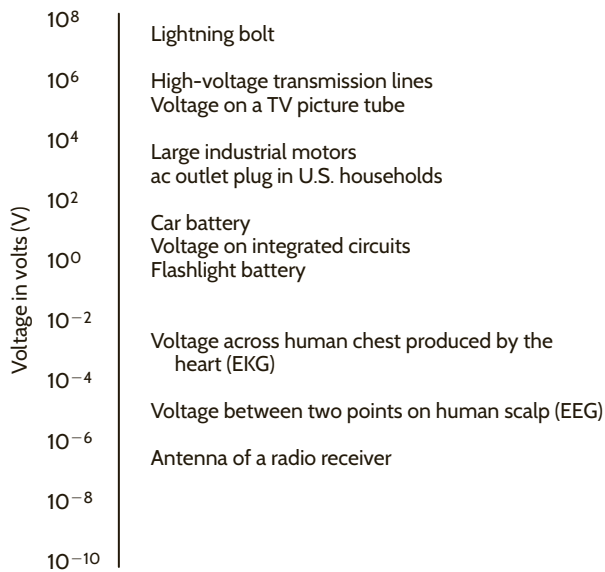

Figure 1.6
Typical voltage magnitudes.

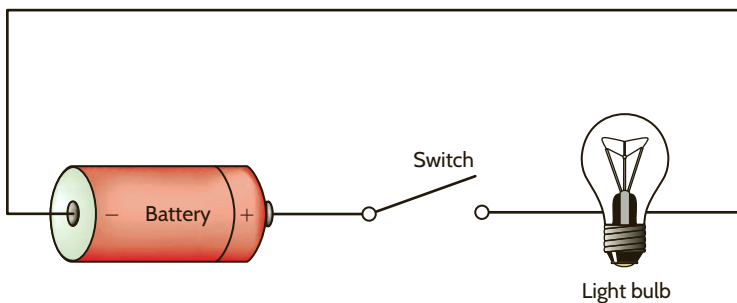

Figure 1.7
Flashlight circuit.

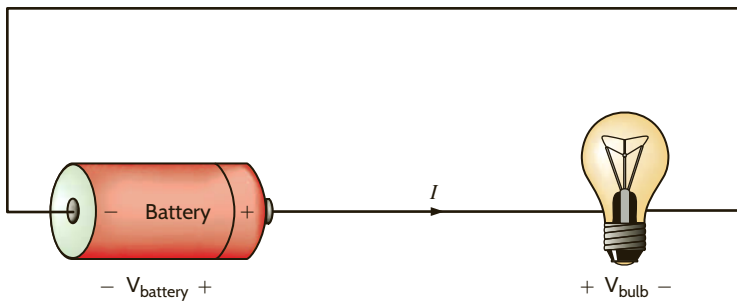
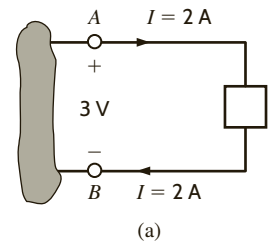
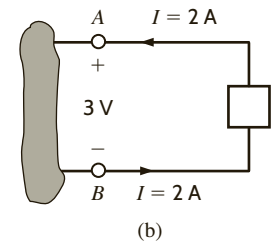

Figure 1.8
Flashlight circuit with voltages and current.



(a)



(b)

Figure 1.9
Voltage–current relationships for (a) energy absorbed and (b) energy supplied.

the battery, the current is leaving the positive terminal, which indicates that energy is being supplied.

This is further illustrated in **Fig. 1.9**, where a circuit element has been extracted from a larger circuit for examination. In **Fig. 1.9a**, energy is being supplied *to* the element by whatever is attached to the terminals. Note that 2 A—that is, 2 C of charge—are moving from point A to point B through the element each second. Each coulomb loses 3 J of energy as it passes through the element from point A to point B. Therefore, the element is absorbing 6 J of energy per second. Note that when the element is *absorbing* energy, a positive current enters the positive terminal. In **Fig. 1.9b** energy is being supplied *by* the element to whatever is connected to terminals A–B. In this case, note that when the element is *supplying* energy, a positive current enters the negative terminal and leaves via the positive terminal. In this convention, a negative current in one direction is equivalent to a positive current in the opposite direction, and vice versa. Similarly, a negative voltage in one direction is equivalent to a positive voltage in the opposite direction.

EXAMPLE 1.1

Suppose that your car will not start. To determine whether the battery is faulty, you turn on the light switch and find that the lights are very dim, indicating a weak battery. You borrow a friend's car and a set of jumper cables. However, how do you connect his car's battery to yours? What do you want his battery to do?

SOLUTION

Essentially, his car's battery must supply energy to yours, and therefore it should be connected in the manner shown in **Fig. 1.10**. Note that the positive current leaves the positive terminal of the good battery (supplying energy) and enters the positive terminal of the weak battery (absorbing energy). Note that the same connections are used when charging a battery.

Figure 1.10

Diagram for Example 1.1.

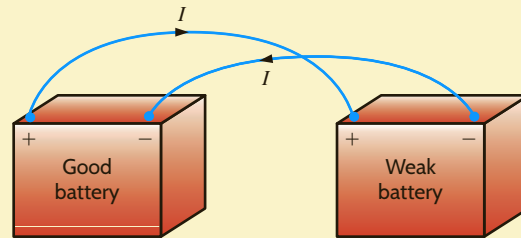

In practical applications, there are often considerations other than simply the electrical relations (e.g., safety). Such is the case with jump-starting an automobile. Automobile batteries produce explosive gases that can be ignited accidentally, causing severe physical injury. Be safe—follow the procedure described in your auto owner's manual.

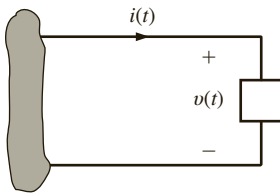

Figure 1.11

Sign convention for power.

We have defined voltage in joules per coulomb as the energy required to move a positive charge of 1 C through an element. If we assume that we are dealing with a differential amount of charge and energy, then

$$v = \frac{dw}{dq} \quad 1.2$$

Multiplying this quantity by the current in the element yields

$$vi = \frac{dw}{dq} \left(\frac{dq}{dt} \right) = \frac{dw}{dt} = p \quad 1.3$$

which is the time rate of change of energy or power measured in joules per second, or watts (W). Since, in general, both v and i are functions of time, p is also a time-varying quantity. Therefore, the change in energy from time t_1 to time t_2 can be found by integrating Eq. (1.3); that is,

$$\Delta w = \int_{t_1}^{t_2} p \, dt = \int_{t_1}^{t_2} vi \, dt \quad 1.4$$

At this point, let us summarize our sign convention for power. To determine the sign of any of the quantities involved, the variables for the current and voltage should be arranged as shown in **Fig. 1.11**. The variable for the voltage $v(t)$ is defined as the voltage across the element with the positive reference at the same terminal that the current variable $i(t)$ is entering. This convention is called the *passive sign convention* and will be so noted in the remainder of this book. The product of v and i , with their attendant signs, will determine the magnitude and sign of the power. If the sign of the power is positive, power is being absorbed by the element; if the sign is negative, power is being supplied by the element.

HINT

The passive sign convention is used to determine whether power is being absorbed or supplied.

Given the two diagrams shown in **Fig. 1.12**, determine whether the element is absorbing or supplying power and how much.

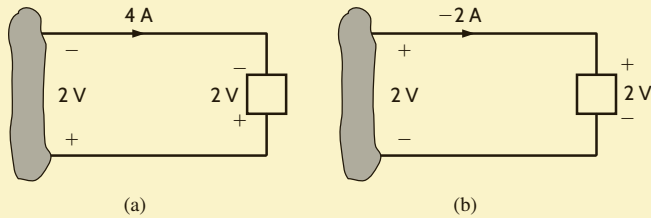

Figure 1.12

Elements for Example 1.2.

In **Fig. 1.12a**, the power is $P = (2\text{ V})(-4\text{ A}) = -8\text{ W}$. Therefore, the element is supplying power. In **Fig. 1.12b**, the power is $P = (2\text{ V})(-2\text{ A}) = -4\text{ W}$. Therefore, the element is supplying power.

SOLUTION

LEARNING ASSESSMENT

E1.1 Determine the amount of power absorbed or supplied by the elements in Fig. E1.1.

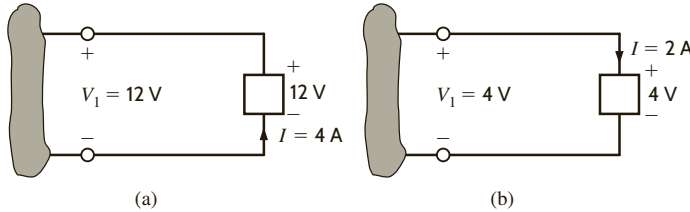

Figure E1.1

ANSWER:

- (a) $P = -48\text{ W}$;
(b) $P = 8\text{ W}$.

We wish to determine the unknown voltage or current in **Fig. 1.13**.

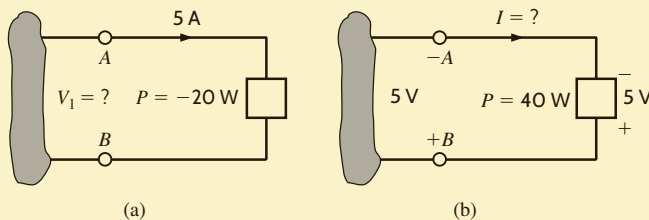

Figure 1.13

Elements for Example 1.3.

In **Fig. 1.13a**, a power of -20 W indicates that the element is delivering power. Therefore, the current enters the negative terminal (terminal A), and from Eq. (1.3) the voltage is 4 V . Thus, B is the positive terminal, A is the negative terminal, and the voltage between them is 4 V .

In **Fig. 1.13b**, a power of $+40\text{ W}$ indicates that the element is absorbing power and, therefore, the current should enter the positive terminal B . The current thus has a value of -8 A , as shown in the figure.

SOLUTION

LEARNING ASSESSMENT

E1.2 Determine the unknown variables in Fig. E1.2.

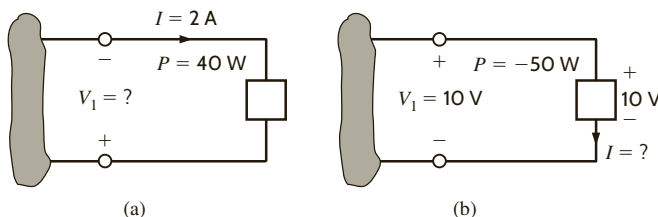

Figure E1.2

ANSWER:

- (a) $V_1 = -20\text{ V}$;
(b) $I = -5\text{ A}$.

Finally, it is important to note that our electrical networks satisfy the principle of conservation of energy. Because of the relationship between energy and power, it can be implied that power is also conserved in an electrical network. This result was formally stated in 1952 by B. D. H. Tellegen and is known as Tellegen's theorem—the sum of the powers absorbed by all elements in an electrical network is zero. Another statement of this theorem is that the power supplied in a network is exactly equal to the power absorbed. Checking to verify that Tellegen's theorem is satisfied for a particular network is one way to check our calculations when analyzing electrical networks.

1.3 Circuit Elements

Thus far, we have defined voltage, current, and power. In the remainder of this chapter we will define both independent and dependent current and voltage sources. Although we will assume ideal elements, we will try to indicate the shortcomings of these assumptions as we proceed with the discussion.

In general, the elements we will define are terminal devices that are completely characterized by the current through the element and/or the voltage across it. These elements, which we will employ in constructing electric circuits, will be broadly classified as being either active or passive. The distinction between these two classifications depends essentially on one thing—whether they supply or absorb energy. As the words themselves imply, an *active* element is capable of generating energy and a *passive* element cannot generate energy.

However, later we will show that some passive elements are capable of storing energy. Typical active elements are batteries and generators. The three common passive elements are resistors, capacitors, and inductors.

In Chapter 2 we will launch an examination of passive elements by discussing the resistor in detail. Before proceeding with that element, we first present some very important active elements.

1. Independent voltage source
2. Independent current source
3. Two dependent voltage sources
4. Two dependent current sources

INDEPENDENT SOURCES An *independent voltage source* is a two-terminal element that maintains a specified voltage between its terminals *regardless of the current through it* as shown by the v - i plot in Fig. 1.14a. The general symbol for an independent source, a circle, is also shown in Fig. 1.14a. As the figure indicates, terminal A is $v(t)$ volts positive with respect to terminal B.

In contrast to the independent voltage source, the *independent current source* is a two-terminal element that maintains a specified current *regardless of the voltage across its terminals*, as illustrated by the v - i plot in Fig. 1.14b. The general symbol for an independent

Figure 1.14

Symbols for (a) independent voltage source and (b) independent current source.

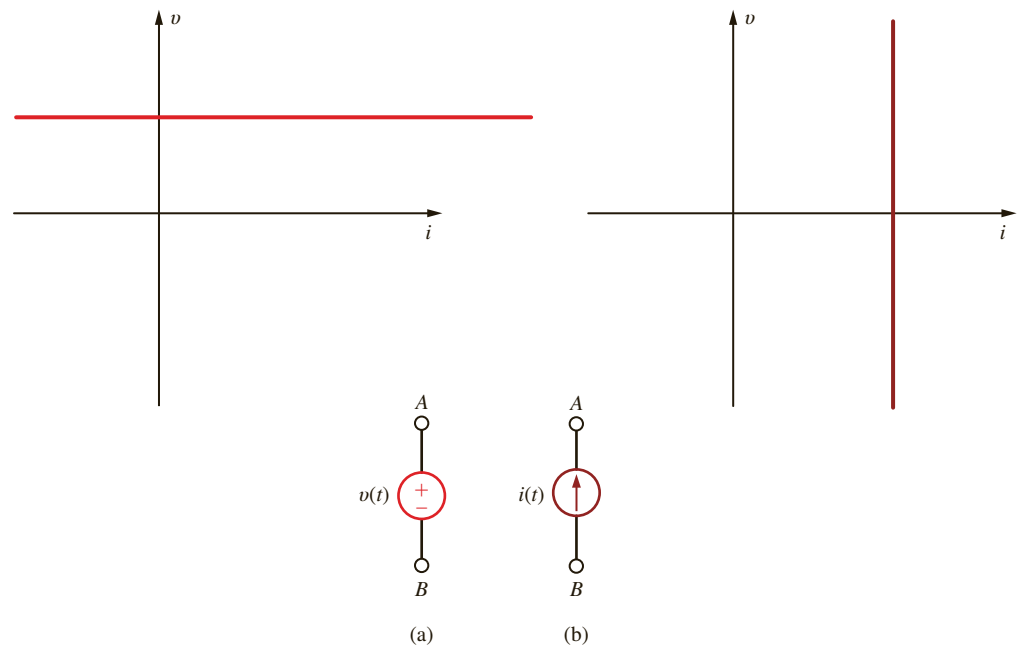

current source is also shown in Fig. 1.14b, where $i(t)$ is the specified current and the arrow indicates the positive direction of current flow.

In their normal mode of operation, independent sources supply power to the remainder of the circuit. However, they may also be connected into a circuit in such a way that they absorb power. A simple example of this latter case is a battery-charging circuit such as that shown in Example 1.1.

It is important that we pause here to interject a comment concerning a shortcoming of the models. In general, mathematical models approximate actual physical systems only under a certain range of conditions. Rarely does a model accurately represent a physical system under every set of conditions. To illustrate this point, consider the model for the voltage source in Fig. 1.14a. We assume that the voltage source delivers v volts regardless of what is connected to its terminals. Theoretically, we could adjust the external circuit so that an infinite amount of current would flow, and therefore the voltage source would deliver an infinite amount of power. This is, of course, physically impossible. A similar argument could be made for the independent current source. Hence, the reader is cautioned to keep in mind that models have limitations and thus are valid representations of physical systems only under certain conditions.

For example, can the independent voltage source be utilized to model the battery in an automobile under all operating conditions? With the headlights on, turn on the radio. Do the headlights dim with the radio on? They probably won't if the sound system in your automobile was installed at the factory. If you try to crank your car with the headlights on, you will notice that the lights dim. The starter in your car draws considerable current, thus causing the voltage at the battery terminals to drop and dimming the headlights. The independent voltage source is a good model for the battery with the radio turned on; however, an improved model is needed for your battery to predict its performance under cranking conditions.

Determine the power absorbed or supplied by the elements in the network in Fig. 1.15.

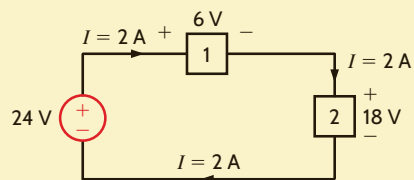

Figure 1.15
Network for Example 1.4.

The current flow is out of the positive terminal of the 24-V source, and therefore this element is supplying $(2)(24) = 48$ W of power. The current is into the positive terminals of elements 1 and 2, and therefore elements 1 and 2 are absorbing $(2)(6) = 12$ W and $(2)(18) = 36$ W, respectively. Note that the power supplied is equal to the power absorbed.

EXAMPLE 1.4



Elements that are connected in series have the same current.

SOLUTION

LEARNING ASSESSMENT

E1.3 Find the power that is absorbed or supplied by the elements in Fig. E1.3.

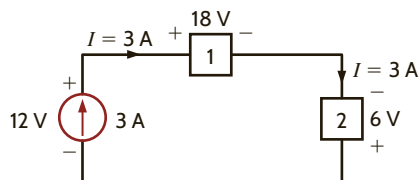

Figure E1.3

ANSWER:

Current source supplies 36 W, element 1 absorbs 54 W, and element 2 supplies 18 W.